

DS7090i Security System User's Guide

An instruction guide for your alarm system

DS7140

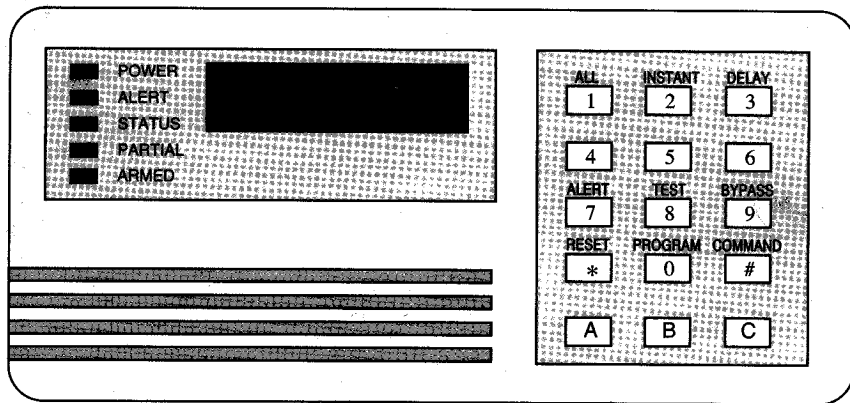

Alpha "English Display" Keypad

DS7092

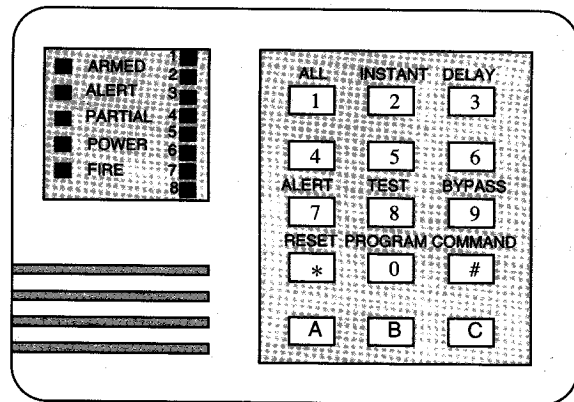

LED Keypad

Table of Contents

System Overview	1
Day To Day Operations	
Understanding the DS7140 Keypad.....	3
Understanding the DS7092 Keypad.....	4
Turning ON (arming) your DS7140 System.....	5
Turning ON (arming) your DS7092 System.....	6
Turning OFF (disarming) your System.....	7
Silencing Alarms.....	7
Custom Arming your System.....	8
Force Arming your System.....	9
Area Bypass.....	10
Alert Mode.....	11
Access Control.....	12
Emergency Procedures	
Identifying Alarm Sounds.....	13
Fire Alarms.....	13
Turning OFF the System Under Duress.....	14
Emergency Keypad Alarms.....	15
Silencing Alarms.....	15
Fire Reset/Fire Trouble.....	16
Fire Safety	
If Installed in Family Residences.....	17
Installation Considerations.....	18
About User Codes	
Changing the Master Code.....	19

Cancelling a User Code.....	19
User Code Chart.....	20

Technical Information

Error Displays for the DS7140 Keypad.....	21
Error Displays for the DS7092 Keypad.....	22
Area Testing your System.....	23

Testing Your System

Battery Test.....	24
Indicator LED Test.....	24
Communicator Test.....	24
Sounder Test.....	24
Test Chart.....	25

Partitioning	27
---------------------------	----

Glossary of Terms	36
--------------------------------	----

Index	38
--------------------	----

Quick Reference Guide	39
------------------------------------	----

System Features Reference Guide	40
--	----

Important

Your system may be monitored by an alarm monitoring service. If it is **not** a monitored system, it is vital for you understand the following:

- Alarms sound only at your location.
- When an alarm is sounded, no signals are sent out.
- Duress and other silent alarms are disabled.
- Emergency alarms sound only at your location.

Day to Day Operations

Understanding the DS7140 Keypad

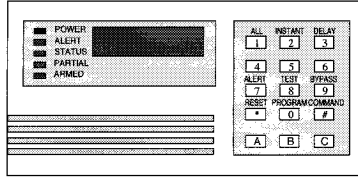

This chart will help you understand what each LED function represents.

The DS7140 is an alpha-numeric keypad that displays information on various control functions. A built-in sounder is used as an interior warning device and to annunciate keystroke entries.

LED	Off	Flashing	On
Power (green)	Control has lost all power. No AC or battery.	Control problems exist (see p.21)	Normal Operation. The control is running on AC power with no problems.
Alert (yellow)	Instant / Alert mode not selected.	A special area is protected.	The control is in the Instant mode when armed, or the Alert mode when disarmed.
Status (green)	One or more areas are not secure.		All areas are secure or bypassed.
Partial (yellow)	No areas are bypassed.	The control has at least one bypassed area.	Only interior areas are bypassed.
Armed (red)	The control is disarmed.	The control is armed and an alarm has occurred, or the control was just armed and is in exit delay.	The control is armed, and no alarms have occurred.

Understanding the DS7092 Keypad

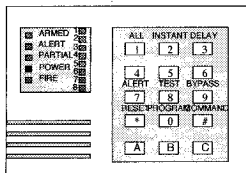

This chart will help you understand what each LED function represents.

The DS7092 contains indicator LEDs that show the system's status. A built-in sounder is used as an interior warning device and to annunciate keystroke entries.

LED	Off	Flashing	On
Armed (red)	Control is disarmed.	The control is armed and an alarm has occurred, or the control was just armed and is in the exit delay.	The control is armed, and no alarms have occurred.
Alert (yellow)	Instant / Alert mode not selected.	A Special Area is protected.	The control is in Instant mode when armed, or Alert mode when disarmed.
Partial (yellow)	No areas are bypassed.	The control has at least one bypassed area.	Only interior areas are bypassed
Power (green)	Control has lost all power. No AC or battery.	Control problems exist. See Page 22.	Normal operation. The control is running on AC power with no problems.
Fire (red)	There have been no Fire Alarms.	There has been a Fire Alarm.	The Fire zone has a problem.
1 - 8 (red)	The area is secure.	Slow Flash: Area is bypassed. Fast Flash : Area has alarmed.	Area is not secure.

Turning ON (arming) your DS7140 System

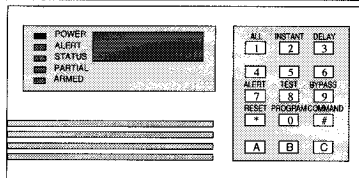

This chart explains the three normal ways of arming the system.

The green Status LED must be on steady and the display must read **READY TO ARM** in order to arm the system with one of these commands.

If the green Status LED is not on, or the display is reading **NOT READY**, then see sections on Force Arming or Area Bypass for ways to arm the system under this condition.

Type of Arming Desired	Enter User code * followed by:	What will Happen	What to Do
Arm Entire System No one on premises, re-entry allowed	COMMAND ALL # 1	<ul style="list-style-type: none"> The red <u>Armed</u> LED will flash, then go steady after the exit delay. ALL SECURE and EXIT NOW will be displayed with the time remaining in the exit delay interval. A single beep may sound. 	Exit during the exit delay interval.
Arm Perimeter Only Someone on premises, no re-entry allowed	COMMAND INSTANT # 2	<ul style="list-style-type: none"> The red <u>Armed</u> LED will flash, then go steady after the exit delay. PERIMETER and EXIT NOW will be displayed with the time remaining in the exit delay interval. A single beep may sound. Yellow <u>Partial</u> and <u>Alert</u> LEDs will come on steady. Only exterior protection areas will be armed. 	Move freely around the interior of the premises.
Arm Perimeter Only Someone on Premises, entry allowed	COMMAND DELAY # 3	<ul style="list-style-type: none"> The red <u>Armed</u> LED will flash, then go steady after the exit delay. PERIMETER DELAY and EXIT NOW will be displayed with the time remaining in the exit delay. A single beep may sound. The yellow <u>Partial</u> LED will come on steady. Only exterior protection areas will be armed. 	Move freely around the interior of the premises.

* User codes may not be needed if the system is programmed in the "Residential Mode" of operation.

Turning ON (arming) your DS7092 System

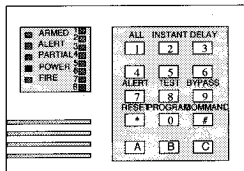

This chart explains the three normal ways of arming the system.

The eight red zone LEDs (right hand row) must be off in order to arm the system with one of these commands.

If they are not off, refer to sections on Force Arming or Area Bypass for ways to arm the system under these conditions.

Type of Arming Desired	Enter User code * followed by:	What will Happen	What to Do
Arm Entire System No one on premises, re-entry allowed	COMMAND ALL (#) (1)	<ul style="list-style-type: none"> The red <u>Armed</u> LED will flash, then go steady after the exit delay. A single beep may sound. 	Exit during the exit delay interval.
Arm Perimeter Only Someone on premises, no re-entry allowed	COMMAND INSTANT (#) (2)	<ul style="list-style-type: none"> The red <u>Armed</u> LED will flash, then go steady after the exit delay. A single beep may sound. The yellow <u>Partial</u> and <u>Alert</u> LEDs will come on steady. Only exterior protection areas will be armed. 	Move freely around the interior of the premises.
Arm Perimeter Only Someone on Premises, entry allowed	COMMAND DELAY (#) (3)	<ul style="list-style-type: none"> The red <u>Armed</u> LED will flash, then go steady after the exit delay. A single beep may sound. The yellow <u>Partial</u> LED will come on steady. Only exterior protection areas will be armed. 	Move freely around the interior of the premises.

* User codes may not be needed.

Turning OFF (disarming) your System / Silencing Alarms

This chart explains proper procedures for disarming and/or silencing alarms.

Please read the section about Emergency Procedures prior to being confronted with an emergency event.

If you have entered the building through a perimeter door, you may hear a steady pre-alert tone from the keypads. If so disarm according to the chart below.

WARNING: If the bells and sirens are on and/or the red Armed LED is flashing with the display reading **AREA ALARM** (DS7140 keypad), and/or the keypad is sounding a pulsing tone; then the keypad is signaling that an alarm has occurred. If the alarm has not been previously investigated, do not enter the building unless accompanied by the appropriate Emergency Services' personnel.

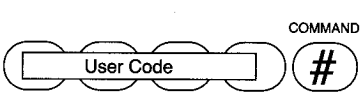
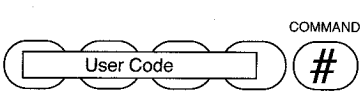
Action Desired	Enter	What will Happen
Disarming System		Red <u>Armed</u> LED will turn off. Pre-alert sounders will silence. Alarms in progress will silence.
Silencing Alarms		Alarms in progress will silence.

* with disarm privileges.

Custom Arming your System

This chart explains the procedure for Custom Arming your system with the three custom designed options pre-programmed by your installer.

Your system may or may not be programmed with Custom Arming modes. These arming modes allow a predetermined set of zones to be armed or bypassed. Ask your alarm service company if this feature is enabled in your system.

Type of Arming Desired	Enter User code * followed by:	What will Happen DS7140 system	What will Happen DS7092 system
Custom Arming	COMMAND (#) (4) or COMMAND (#) (5) or COMMAND (#) (6)	<ul style="list-style-type: none"> • The red <u>Armed</u> LED will flash, then go steady after the exit delay. • The yellow <u>Alert</u> and/or <u>Partial</u> LEDs will come on steady. • INSTANT, PARTIAL INSTANT or PARTIAL DELAY, and EXIT NOW will be displayed with the time remaining in the exit delay interval. • A single beep may sound. • A three-beep error tone indicates an improper code entry or that custom arming is disabled. The display will read ENTRY ERROR. PLEASE REENTER. 	<ul style="list-style-type: none"> • The red <u>Armed</u> LED will flash then go steady after the exit delay. • The yellow <u>Alert</u> and/or <u>Partial</u> LEDs will come on steady. • A single beep may sound. • A three-beep error tone indicates an improper code entry or that custom arming is disabled.

If leaving the premises, exit during the exit delay interval.

* User codes may not be needed.

This feature must be disabled on UL certificated installations.

Force Arming your System

This chart explains the procedure for Force Arming your system if one or more zones are faulted.

When one or more zones are faulted, the system may be force armed by bypassing the faulted zones. The 7140's green Status LED will be off and the display will read **NOT READY** followed by the faulted zone. The 7092 will light the faulted zone's LED.

Force Arming during AC power failure: Regular arming of the control panel is not permitted during an AC power failure. Having to force arm serves as a warning that the control panel is operating under backup battery.

WARNING

Bypassing or force arming removes some of your building's protection because it excludes the faulted zones from arming. Therefore, an intrusion may not be detected or the detection may be delayed. Always attempt to correct any area problems (close doors and windows etc.) before using these features. If the problem can not be corrected, contact your installing company.

Note: See Area Bypass for an alternate method of arming the system when faults exist.

Type of Arming	Enter User code * followed by:	What will Happen	What to do	What will Happen	What to do
Force Arming	COMMAND (#) (1) or COMMAND* (#) (2) or COMMAND (#) (3)	<ul style="list-style-type: none"> A five second beep occurs, indicating the control has faulted zones and needs to be force armed or a three-beep error tone occurs indicating force arming has not been accepted or allowed. 	Press BYPASS (9) during 5 second beep.	<ul style="list-style-type: none"> Red <u>Alarm</u> LED will flash during the exit delay. Control will arm with faulted zones bypassed 	Exit during the exit delay interval if leaving the premises.

* User codes may not be needed.

This feature must be disabled on UL certificated installations.

Area Bypass

This chart explains the procedure for Bypassing a faulted zone prior to arming the system.

There may be occasions when it is desirable or necessary to temporarily bypass one or more zones prior to arming the system. Bypass commands only work when the control is disarmed. For instance, an open window may cause the 7140 display to read **NOT READY** followed by the faulted

area number. If the area number is not showing after **NOT READY**, press the [Command/#] key. The 7092 will light the faulted zone's LED.

Only one area may be bypassed each time the command is used. If more than one area requires bypassing, repeat the command for each area to be bypassed.

Note: See Force Arming for another method of area bypassing.

Bypass command	Enter User code * followed by:	What will Happen DS7140 system	What will Happen DS7092 system	What to do
Bypass Faulted Zones	COMMAND BYPASS (#) (9) [Area No. 1-8]	<u>Partial</u> LED will come on steady or flash.	<u>Partial</u> LED will come on steady or flash. Bypassed zone LED will flash.	Arm panel, if desired, (entered zones bypassed).
Read Bypassed Zones	COMMAND BYPASS (#) (9)	"Area Bypass <input type="checkbox"/> <input type="checkbox"/>		
Clear Individual Bypassed Zone(s)	COMMAND BYPASS (#) (9) [Area No. 1-8]	"Area Bypass" will be cleared. <u>Partial</u> LED will be off unless zones are still bypassed.	<u>Partial</u> LED will go out; LED for Bypassed zone will go back to steady on if zone is still faulted.	
Clear All Bypassed Zones	COMMAND BYPASS RESET (#) (9) (*)	All Bypasses will be cleared. The <u>Partial</u> LED will turn off.	All Bypasses will be cleared.	

* User codes may not be needed. Arming and disarming the control also clears bypassed zones, unless they are 24 hour zones.

Alert Mode

This chart explains the procedure for activating the Alert Mode.

This mode causes the keypad sounders to beep each time a Perimeter or Entry / Exit area is violated while the control panel is turned off (disarmed).

Action Desired	Enter User code * followed by:	What will Happen
Alert Mode	COMMAND # ALERT 7	<ul style="list-style-type: none">• When the control panel is turned off (disarmed), the yellow <u>Alert</u> LED will be on at all keypads.• Arming and disarming the control panel does not affect the Alert mode, although the <u>Alert</u> LED may turn off during armed periods.

* User codes may not be needed.



Note: To disable Alert mode, repeat the # 7 sequence.

Access Control

This chart explains the procedure for activating devices that require an Access Control Code.

Your system may or may not use a keypad key sequence to activate other electrical devices. The special code required to perform this function is known as an Access Control Code. This feature can be used in armed or disarmed modes.

The code may control devices that activate for a short period of time (e.g. electric locking mechanisms on a door), or devices that stay on until a subsequent re-entry of the Access Control Code. In both cases, the entry sequence is the same.

		What will Happen DS7140 system	What will Happen DS7092 system
Momentary ON/OFF Access Control Activation		<ul style="list-style-type: none"> • The display will read "Output ON." • The access device will be activated for the programmed length of time. 	The access device will be activated for the programmed length of time.
Alternate ON/OFF Access Control Activation		<ul style="list-style-type: none"> • The display will read "Output ON" after the first entry of the code and "Output OFF" after the second entry. • Each entry of the access control code will switch the output to the alternate state. 	Each entry of the access control code will switch the output to the alternate state.

This feature must be disabled on all UL certificated installations.

Emergency Procedures

Identifying Alarm Sounds

Your alarm system may be programmed for a steady alarm sound or a pulsed alarm sound. It is important to learn the difference between a fire alarm sound and an intrusion alarm sound before you are confronted with an actual emergency.

Silencing Alarms

All alarms can be silenced with any user code that has disarm privileges. Entering your user code will silence the alarm and turn off (disarm) the control.

A Cautionary Note

How you respond to an alarm will depend, mostly, on the type and time of the alarm. You should seek the advice of your installing company as they install your system, **not** later (e.g. after an alarm) to develop a response plan.

Above all else, common sense should prevail.

If there is any threat or hint of danger to yourself or others on the premises, such as in the event of a fire alarm, everyone should be instructed to leave the premises immediately. Do not enter the premises unless accompanied by the appropriate Emergency Services' personnel, or after they have given the OK to enter.

Caution When Entering A Building.

If the bells and sirens are on and/or the red Armed LED is flashing with the display reading **AREA ALARM** (7140), and/or the keypad is sounding a pulsing tone; then the keypad is signaling that an alarm has occurred. If the alarm has not been previously investigated, **do not enter the building unless accompanied by the appropriate Emergency Services' personnel.**

Fire Alarms

Fire Alarms are silenced using the same procedure as intrusion alarms: a user code followed by the command/# key.

The Fire Alarm system is **not** reset until alarms at smoke detectors are cleared by using the FIRE RESET command. The Fire Alarm system will **not** be functional until this procedure has been followed. See "Fire Reset" on page 16.

Turning OFF the System Under Duress

This chart explains the procedure for disarming with a Duress code

Ask your installer if the Duress feature has been activated.

Disarming with a code one digit higher than your User code is disarming with a Duress code. A Duress code is used when someone demands, by threatening your life or well-being, that the system be turned off. When used, the code will both turn off the system and report a silent duress alarm if connected to a monitoring service. Extreme care should be used when entering your user code to turn off the system, so a Duress code is not inadvertently entered.

Example: If this feature is enabled and your User code is 222, then 223 would be your Duress code. The control panel will give no indication that a Duress code has been used, and will outwardly respond the same as if a normal Disarming code were used.

Note: Be careful of User codes that end in 9.
 Example: If your User code is 229, then the Duress code is 220, **not** 230.

Type of Disarming	Enter this code	What will Happen
Disarming System		<p>Red Armed LED will turn off. If the pre-alert is sounding, it will silence.</p>
Disarming System Under Duress		<p>System will appear to disarm normally as described above, but a Duress alarm will be reported to your monitoring service.</p>

* with disarm privileges.

Emergency Keypad Alarms / Silencing Alarms

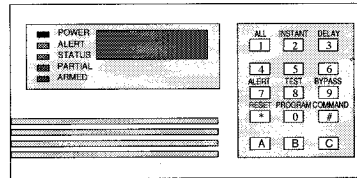

The Alarm Keys [A], [B], and [C] may generate Fire, Supplemental, and Silent alarms if programmed by the installer. Ask your installing company to explain the function of these keys.

When using the Alarm Keys, they must be pressed for two seconds to generate an alarm.

Use the Disarming command sequence to cancel or silence these alarms.

Fire Reset / Fire Trouble

During a fire alarm, exit the premises immediately. When you have determined there is no fire, you must silence the bells/sirens before you can initiate the fire reset command.

Before the fire command is used, determine which smoke detector has alarmed so the monitoring company may verify its operation.

A User code* followed by the command below



will reset any smoke detectors after a fire alarm has occurred. The command initiates two functions: it resets smoke detectors and performs a battery test. The Power LED will flash for 10 seconds during reset.

* A User code may not be needed.

A Fire Trouble message signifies a problem with the fire system, such as a break in the wiring that monitors smoke detectors. Fire Trouble will be indicated by a short beep from the keypad sounders every 5 seconds, accompanied by a message of **FIRE TROUBLE** in the 7140 display; the Fire LED on the 7092 will come on steady. Notify your installing company immediately if the Fire Trouble message is displayed.

The Fire Trouble beep can be silenced with any User code followed by the [Command/#] key. After problems have been remedied, a User code followed by the [Command/#] key should again be entered to clear the **FIRE TROUBLE** display.

Fire Safety

WARNING: No fire detection device or system should be considered 100 percent fool proof.

This fire alarm system can provide early warning of a developing fire. Such a system, however, does not ensure protection against property damage or loss of life resulting from a fire. Any fire alarm system may fail to warn for any number of reasons (e.g. smoke not reaching a detector that is behind a closed door).

When considering detectors for residential applications, refer to NFPA Standard 74, "Household Fire Warning Equipment." These standards are available at a nominal cost from: The National Fire Protection Association, Batterymarch Park, Quincy, MA. 02269.

If Installed in Family Residences

Adherence to the NFPA Standard 74 can lead to reasonable fire safety when the following items are practiced:

- **Minimize hazards:** Avoid the three traditional fire killers: smoking in bed, leaving children home alone, and cleaning with flammable liquids.
- **Providing a fire warning system:** Most fire deaths occur in the home, the majority, during sleeping hours. The minimum level of protection requires smoke detectors to be installed outside of each separate sleeping area and on each additional story of the dwelling.

For added early warning protection, it is recommended that detectors be installed in all separated areas including the basement, bedrooms, dining room, utility room, furnace room, and hallways.

Having and Practicing an Escape Plan

A fire warning may be wasted unless the family has planned in advance for a rapid and safe exit from the building.

- Draw a floor plan of the entire house showing **two** exits from each bedroom and **two** from the house. Since stairwells and hallways may be blocked during a fire, the plan should provide exits from bedroom windows.

Make copies of the plan and practice it with all family members.

- Pre-arrange a meeting place **outside and away from the residence**. Once out of the building, all occupants should immediately go to the pre-selected location to be accounted for.

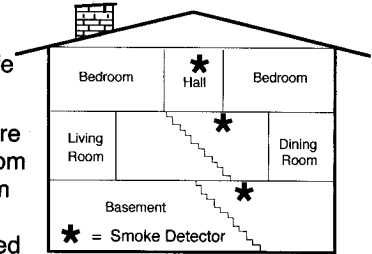

A smoke detector should be located on each story including basements, but excluding crawl spaces and unfinished attics.

Fire Safety (continued)

- Provide a barricade between family members and fire, smoke, and toxic gases (e.g. close all bedroom doors before retiring).
- Children should be instructed on opening their bedroom windows and exiting safely from the building. If exiting is not possible, they should be taught to stay at the open window and shout for help until it arrives.
- In the event of a fire alarm after retiring, wake the children by shouting to them from behind your closed door. Tell them to keep their bedroom doors closed.
- **If the top of your bedroom door is uncomfortably hot, do not open it.** There is most likely fire, intolerable heat, or smoke on the other side. Shout to all family members to keep their bedroom doors closed and to exit the building via alternate routes.
- If the top of the door is not uncomfortably hot, brace the bottom of the door with your foot, and the top with one hand, then open the door about one inch. Be prepared to slam the door shut if there is any pressure against the door or if any hot air rushes in.
- If there is no evidence of excessive heat or pressure, **leave the room and close the door behind you.** Shout appropriate instructions to all family members and immediately leave the building via the pre-planned routes. If heavy smoke is present, drop to your hands and knees, or crawl to remain below the smoke level.

Installation Considerations

Proper location of detection devices is one of the most critical factors in a fire alarm system.

The following are some general considerations:

- Smoke detectors should **not** be installed in "dead air" spaces or close to ventilating or airconditioning outlets because smoke may be circulated away from the detector. Locations near air inlets should be favored.

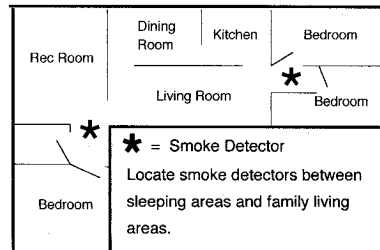

- Avoid areas subject to normal smoke concentrations such as kitchens, garages, or near fireplaces.
- Do not install smoke detectors where normal area temperatures are above 100 degrees F (38 degrees C) or below 32 degrees F (0 degrees C).
- Areas of high humidity and dust concentrations should be avoided.
- The edge of ceiling mounted detectors should be no closer than 4 inches (10 cm) from any wall.
- Place the top edge of wall mounted detectors between 4 and 12 inches (10 to 30 cm) from the ceiling.

About User Codes

General Information

Note: See glossary for definitions on User number and User code.

Your system has room to program 15 User codes. Each code may be from one to five digits (they should be programmed for at least 3 digits). Each Code can have only one User Number (1 to 15). Attempting to assign the same User Code to two different User numbers will result in the three-beep error tone, and the change will not be made. User number 01 must be a Master code and requires [Auth] =1.

A Master code can be used to add, delete, read back, or change other User codes. Code Number 01 is shipped from the factory with the sequence of 1 2 3 4. This code should be changed to one of your personal preference, and must be programmed as a Master code. User codes should never be programmed with common sequences such as 1234, 1111, or 2468.

Authority Levels

- **Master code:** Has all privileges, including the ability to change other codes.
- **Arming Only codes:** May be used by people who lock up a building but do not need the responsibility of opening (disarming) the system.

- **Temporary codes:** Short time User codes that work only until a permanent code is used to disarm the system. For instance, they could be for one time usage of babysitters or cleaning services.

Changing the Master code

For our example we will change the four digit factory pre-set Master code of 1 2 3 4, to a new three digit Master code of 3 7 4.



The Master code would be User number 01, so the Authority must be set to 1 (Auth =1).

If entered correctly, a long beep will sound. Wait no longer than 20 seconds between key presses when entering the new code information, or the three beep error tone will sound and the sequence will have to be restarted.

Cancelling a User code

To cancel an existing code, enter a Master code, [Command/#] [Program/0], the User code number to be cancelled, and then [Command/#] again.

Note: User number 01 can not be cancelled in this manner. User number 01 can be changed as explained above, but not cancelled.

About User Codes (continued)

This chart explains the procedure for changing or creating a User code

Steps to change a User code	Enter	If accepted, the DS7140 will display
1. Enter Program Mode		"ENTER USER NUMBER (01-15)"
2. Enter a 2-digit User number		"ENTER FUNCTION CODE DIGIT"
3. Enter Authority Level		"ENTER USER CODE END WITH # KEY"
4. Enter 1 - 5 Digit New User Code		Long beep sounds signifying acceptance of the new code.

Authority (Function Code Digit)

0 = Service Code, all privileges.

1 = Master Code, pass code changes, arm, disarm, force arming, bypassing, and system test.

2 = Arm, disarm, force arming, bypassing, and system test.

3 = Arm, disarm, force arming, and bypassing.

4 = Arm, disarm.

5 = Temporary code, arm, disarm.

6 = Arming only, force arming and bypassing.

7 = Arming only.

8 = Temporary code, arming only.

9 = Access control code.

Technical Information / Error Displays for the DS7140 Keypad

This chart explains the procedure for reading Error messages when the green Power LED is flashing.

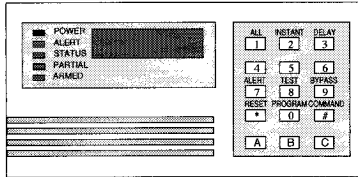

Control problems are indicated by a flashing green Power LED. If the green Power LED is flashing, one of the following problems exist. The Error messages may only be read when the control is disarmed. Contact your installing company if the problems persist.

1. **AC Power Failure:** This display can not be cleared.
2. **Low Battery:** If the system has just been through a power failure, wait at least two hours for the battery to recharge, then enter #80 to perform a battery test.
3. **Communication Failure:** The communicator failed to communicate with the central station.
4. **EEProm Error:** Internal error in the control memory. Call for service immediately.
5. **Low Aux. Power:** Internal component failure or an external short.

	Enter User code* followed by:	DS7140
Read Error Message when green <u>Power</u> LED is flashing	COMMAND TEST ALERT (#) (8) (7)	Display will flash appropriate Error message twice then return to the previous screen after the 3 beep error tone: <ul style="list-style-type: none"> AC Power Failure. Using battery.** Low Battery. Service required. Communication Failure EEProm Error Low Aux. Power. Service required.
Clear Error Display	COMMAND TEST ALERT RESET (#) (8) (7) (*)	Caution: Clear the error display only on the advice of your installing company or if you are certain the identified problem has been remedied.

* User codes may not be needed.

** To arm the system during an AC power Fail Condition, see "Force Arming" on page 9.

Technical Information / Error Displays for the DS7092 Keypad

This chart explains the procedure for reading Error messages when the green **Power** LED is flashing.

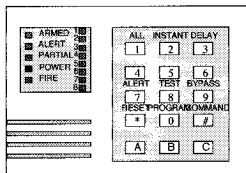

Control problems are indicated by a flashing green **Power** LED. If the green **Power** LED is flashing, one of the following problems exist. The Error messages may only be read when the control is disarmed. Contact your installing company if the problems persist.

1. **AC Power Failure:** This can not be cleared.
2. **Low Battery:** If the system has just been through a power failure, wait at least two hours for the battery to recharge, then enter #80 to perform a battery test.
3. **Communication Failure:** The communicator failed to communicate with the central station.
4. **Low Aux. Power:** Internal component failure or an external short.
5. **EEProm Error:** Internal error in the control memory. Call for service immediately.

	Enter User code* followed by:	DS7092
Read Error Message when green Power LED is flashing	COMMAND TEST ALERT (#) (8) (7)	<p> LED 1 = AC power failure. Using battery.** LED 2 = Battery problem. Missing or low voltage. LED 3 = Communicator failed to communicate. LED 4 = Low AUX power. LED 5 = Internal system fault (EEPROM). Fire LED = Internal system fault (EPROM or RAM). </p> <p>The 3 beep error tone sounds when the red indicator LEDs and the Fire LED return to their previous states.</p>
Clear Flashing LED	COMMAND TEST ALERT RESET (#) (8) (7) (*)	<p>Caution: Clear the flashing LED only on the advice of your installing company or if you are certain the identified problem has been remedied.</p>

* User codes may not be needed.

** To arm the system during an AC power Fail Condition, see "Force Arming" on page 9.

Technical Information / Area Testing your System

This chart explains the procedure for performing an Area Test.

The Area Test is used to confirm that detectors will report an alarm to the control panel. Area Test works on all burglary areas. The Fire Zone, however, is not affected and will function normally. While in Area Test, no control panel alarms will occur except a fire alarm, which will override the Area Test function.

Type of Test	Enter User code * followed by:	What will Happen	What to Do
Area Test	COMMAND TEST ALL (#) (8) (1)	<ul style="list-style-type: none"> The green <u>Status</u> LED will come on steady while the yellow <u>Partial</u> and red <u>Armed</u> LEDs will pulse on and off. (7140) The yellow <u>Partial</u> and red <u>Armed</u> LEDs will pulse on and off. (7092) All keypad sounders will turn on continuously while any area is violated. <p>The 7140 display reads "UNTESTED AREA" indicating areas that have not been tested during the area test.</p> <p>The red LEDs on the 7092 display labeled 1-8 flash indicating areas that have not been tested during the area test.</p>	<p>Test each detector one at a time as instructed by the installing company.</p> <p>"ALL AREAS TESTED" will be displayed (7140) when all areas have been tested.</p> <p>When each area is tested, its corresponding LED will go out (7092).</p> <p>To exit the Area Test mode at any time, press [Reset/*].</p>

* User codes may not be needed.

Testing your System

Note: These tests can only be performed when the control panel is disarmed.

Battery Test

In the event of a power failure, your control panel has a built-in battery that will continue to power the control panel for many hours. The control panel automatically recharges the battery when power is restored.

In addition to an automatic battery test performed every 24 hours, the battery may also be tested manually. It can be tested with an alarm sounder load by entering # 8 5. It can be tested without the alarm sounder load by entering # 8 0 (fire reset).

Note: Testing the battery with the # 8 0 command will reset any smoke detectors that may be in an alarm condition.

Indicator LED Test

This test will turn on all keypad LEDs and display segments for 5 seconds. Use this test to confirm that the keypad indicator LEDs are in working condition.

Communicator Test

This test is available only if your system transmits alarms and system information to a monitoring service, and has been programmed by the installing company to permit communicator tests. A long beep will initially sound to acknowledge the start of the test and the Power LED will start flashing. If the test is successful, the sounder will again issue one long beep, and the Power LED will return to normal. If the test fails, the Power LED will continue to pulse. The keypad sounder will turn ON continuously until the [Reset/*] key is pressed. (See Error Display if the Power LED continues to flash.)

Sounder Test

This test manually activates all the system sounders for 2 seconds. It also tests the battery.

The chart on the next page explains the procedures for testing your system.

Testing your System (continued)

If the problems persist, contact your installing company.

Type of Test	Enter User code * followed by:	What will Happen	What to Do
Battery Test	COMMAND TEST PROGRAM (#) (8) (0) <small>SAME AS FIRE RESET COMMAND</small>	<ul style="list-style-type: none"> The green <u>Power</u> LED will flash on and off during the test. The <u>Power</u> LED will return to normal after 10 seconds if the battery tests OK. The <u>Power</u> LED will continue to flash if the test fails. 	If power in your building has been off recently, wait 2 hours for the battery to recharge, then try again.
Communicator Test	COMMAND TEST INSTANT (#) (8) (2)	<ul style="list-style-type: none"> A long beep will sound. The green <u>Power</u> LED will flash on and off. A "Test" report is sent to the monitoring service. If test fails, sounders continuously sound. Silence by pressing the [Reset/*] key. 	<p style="text-align: center;">CAUTION:</p> Call your monitoring service listed on the back cover before testing the communicator.
Indicator LED Test	COMMAND TEST (#) (8) (4)	<ul style="list-style-type: none"> All keypad LEDs and display segments will come on steady for 5 seconds. At the end of this time, the LEDs will return to their previous state and 3 beeps will sound. 	If any LEDs or segments do not come on steady, contact your installing company.
Sounder Test and Battery Test	COMMAND TEST (#) (8) (5)	<ul style="list-style-type: none"> The keypad sounders and all alarm sounding devices will operate for 2 seconds. The battery will be tested. 	Check error display if the <u>Power</u> LED continues flashing after the 2 second test. Call the Installing company if alarm sounding devices don't sound.

* User codes may not be needed.

Testing your System (continued)

Type of Test	Enter User code * followed by:	What will Happen	What to Do
<p>Alarm History Readback</p>	<p>COMMAND TEST BYPASS</p> <p>(#) (8) (9)</p>	<ul style="list-style-type: none"> • The 7092 will display the last alarm event by flashing the zone LEDs. If more than one zone was violated during the last alarm event, the first zone to be violated will flash fast; all other violated zones will flash slowly. • The 7140 will display AREA ALARM, followed by the zone number. The display will scroll through each violated zone. <p>Each keypad will only display for a few seconds, then return to its previous state.</p> <p>If the 3 beep error tone occurs after this command, the Alarm History is clear/empty.</p>	
<p>Alarm History Reset</p>	<p>COMMAND TEST BYPASS</p> <p>(#) (8) (9) (*)</p>	<ul style="list-style-type: none"> • Zone LEDs that are flashing to indicate a previous alarm will turn off on the DS7092. This command also clears the Alarm History. 	

* User codes may not be needed.

Partitioning

Note: This section only describes those functions that behave differently when in Partition mode. For a complete description the system, refer to the previous section.

The 8 zones of the 7090i may be divided into two partitions. An advantage of this feature is that it allows you to divide a building into two units separating for example, the offices from the warehouse. It allows you to provide separate security for two different areas from one security system. Individual zones may be assigned to one of the two partitions, or may be shared by both partitions. Users can be assigned to one partition or both. The DS7090i must be pre-programmed by your installer for partitioning.

When you are in the partitioning mode, some operations of the DS7090i will work differently. A brief outline follows:

- **Commercial Mode:** The control panel will always be in commercial mode when partitioning is selected. User codes are required for all system commands.
- **Fire Zone:** The fire zone is shared by both partitions. Users having access to either partition may silence and reset the fire zone.
- **Custom Arming:** Custom Arming is not allowed when in Partition mode.
- **Special Area Protection:** Special Area Protection is not allowed when in Partition mode.
- **Sirens:** Entering a user code for one partition will not turn off the sirens if the other partition is armed and there has been an alarm on one of its zones.
- **LEDs:** Some functions of the LEDs will be different when in Partition mode. They are described on the following pages.
- **User codes:** When in Partition mode, User codes must be used before any system commands. User codes must also correspond with the partition you wish to work with. See page 40 for a complete explanation of User codes in relation to partitioning.
- **General Display messages:** The DS7140 will toggle back and forth between messages for partition 1 and 2 if they are different.

Partitioning (continued)

Understanding the DS7140 Keypad

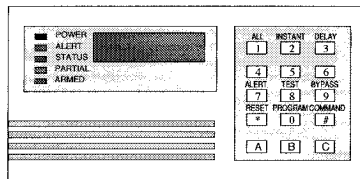

This chart will help you understand what each LED function represents while in Partition mode.

The DS7140 is an alpha-numeric keypad that displays information on various control functions. A built-in sounder is used as an interior warning device and to annunciate keystroke entries.

LED	Off	Flashing	On
Power (green)	Control has lost all power. No AC or battery.	Control problems exist (see p.21).	Normal Operation. The control is running on AC power with no problems.
Alert (yellow)	Partition 1 is disarmed.	Partition 1 is perimeter armed.	Partition 1 is armed.
Status (green)	One or more areas are not secure.		All areas are secure or bypassed.
Partial (yellow)	Partition 2 is disarmed.	Partition 2 is perimeter armed.	Partition 2 is armed.
Armed (red)	The control is completely disarmed.	The control is armed and an alarm has occurred, or one or both partitions were just armed and is in exit delay.	The control is armed in some way, and no alarms have occurred.

Partitioning (continued)

Understanding the DS7092 Keypad

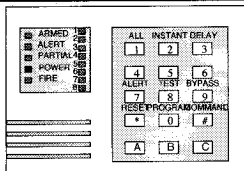

This chart will help you understand what each LED function represents while in Partition mode.

The DS7092 contains indicator LEDs that show the system's status. A built-in sounder is used as an interior warning device and to annunciate keystroke entries.

LED	Off	Flashing	On
Armed (red)	Control is completely disarmed.	The control is armed and an alarm has occurred, or one or both partitions were just armed and the control is in exit delay.	The control is armed in some way. No alarms have occurred.
Alert (yellow)	Partition 1 is disarmed.	Partition 1 is perimeter armed.	Partition 1 is armed.
Partial (yellow)	Partition 2 is disarmed.	Partition 2 is perimeter armed.	Partition 2 is armed.
Power (green)	Control has lost all power. No AC or battery.	Control problems exist. See Page 22.	Normal operation. The control is running on AC power with no problems.
Fire (red)	There have been no Fire Alarms.	There has been a Fire Alarm.	The Fire zone has a problem.
1 - 8 (red)	The area is secure.	Slow Flash: Area is bypassed. Fast Flash : Area has alarmed.	Area is not secure.

Partitioning (continued)

Arming

Like all other commands in partition mode, in order to arm the system, your User code must correspond with the partition you wish to arm.

If you need access to arm partition 1 only, then your User code must begin with a 1.

If you need access to arm partition 2 only, then your User code must begin with a 2.

If you need access to arm both partitions simultaneously, then your User code must begin with a 0.

Master codes work the same way as User codes. Master codes beginning with a 1 are for use with partition 1. Master codes beginning with 2 are for use with partition 2. And Master codes that begin with a 0 are for use with both partitions.

Custom arming is not allowed when in Partition mode.

Partitioning (continued)

Turning ON (arming) your DS7140 Partition

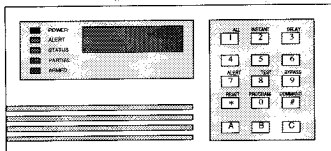

This chart explains the three normal ways of arming the partition.

The display for your partition must read **READY TO ARM** in order to arm the partition with one of these commands.

If the display for your partition is reading **NOT READY**, then see section on Force Arming or Area Bypass for ways to arm the partition under these conditions.

Type of Arming Desired	Enter User code followed by:	What will Happen	What to Do
Arm Entire Partition No one in partition(s), re-entry allowed	COMMAND ALL (#) (1)	<ul style="list-style-type: none"> The red <u>Armed</u> LED will flash, then go steady after the exit delay. ALL SECURE and EXIT NOW will be displayed for partition(s) during exit delay interval. LED(s) for partition(s) being armed come on steady. 	Exit partition(s) during the exit delay interval.
Arm Perimeter Only Someone in partition(s), no re-entry allowed	COMMAND INSTANT (#) (2)	<ul style="list-style-type: none"> The red <u>Armed</u> LED will flash, then go steady after the exit delay. PERIMETER and EXIT NOW will be displayed for partition(s) during the exit delay interval. A single beep may sound. LED(s) for partition(s) being armed will flash. Only exterior protection areas will be armed. 	Move freely around the interior of the partition(s).
Arm Perimeter Only Someone in partition(s), entry allowed	COMMAND DELAY (#) (3)	<ul style="list-style-type: none"> The red <u>Armed</u> LED will flash, then go steady after the exit delay. PERIMETER DELAY and EXIT NOW will be displayed for partition(s) during exit delay interval. A single beep may sound. LED(s) for partition(s) being armed will flash. Only exterior protection areas will be armed. 	Move freely around the interior of the partition(s).

Partitioning (continued)

Turning ON (arming) your DS7092 Partition(s)

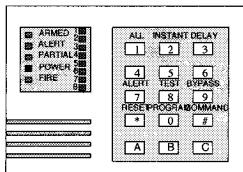

This chart explains the three normal ways of arming the partition.

The red LEDs for the zones in your partition (right hand row) must be off in order to arm the partition with one of these commands.

If they are not off, refer to sections Force Arming or Area Bypass for ways to arm the partition under these conditions.

Type of Arming Desired	Enter User code followed by:	What will Happen	What to Do
Arm Entire Partition No one in partition(s), re-entry allowed	COMMAND ALL # 1	<ul style="list-style-type: none"> The red <u>Armed</u> LED will flash, then go steady after the exit delay. LED(s) for partition(s) being armed will come on steady. 	Exit partition(s) during the exit delay interval.
Arm Perimeter Only Someone in partition(s), no re-entry allowed	COMMAND INSTANT # 2	<ul style="list-style-type: none"> The red <u>Armed</u> LED will flash, then go steady after the exit delay. A single beep may sound. LED(s) for partition(s) being armed will flash. Only exterior protection areas of the partition(s) will be armed. 	Move freely around the interior of the partition(s).
Arm Perimeter Only Someone in partition(s), entry allowed	COMMAND DELAY # 3	<ul style="list-style-type: none"> The red <u>Armed</u> LED will flash, then go steady after the exit delay. A single beep may sound. LED(s) for partition(s) being armed will flash. Only exterior protection areas of the partition(s) will be armed. 	Move freely around the interior of the partition(s).

Partitioning (continued)

Turning OFF (disarming) your Partition(s)

This chart explains proper disarming procedures while in Partition mode.

Please read the section about Emergency Procedures (p.13) prior to being confronted with an emergency event.

If you have entered the building through a perimeter door, you may hear a steady pre-alert tone from the keypads. If so disarm according to the chart below.

WARNING: If the bells and sirens are on and/or the red Armed LED is flashing with the display reading **AREA ALARM** (DS7140 keypad), and/or the keypad is sounding a pulsing tone; then the keypad is signaling that an alarm has occurred. If the alarm has not been previously investigated, do not enter the building unless accompanied by the appropriate Emergency Services' personnel.

User codes for disarming work in the same way as they do for arming:

If you need to disarm partition 1 only, then your User code must begin with a 1.

If you need to disarm partition 2 only, then your User code must begin with a 2.

If you need to disarm both partitions simultaneously, then your User code must begin with a 0.

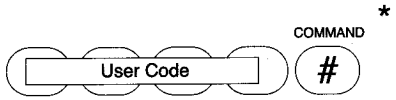
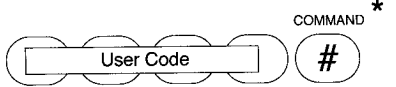
Action Desired	Enter	What will Happen
Disarming partition(s)		Red <u>Armed</u> LED will turn off if no other partition is armed. Pre-alert sounders will silence. Alarms in progress will silence if they occurred in the partition(s) being disarmed.
Silencing Alarms		Alarms in progress will silence if they occurred in the partition(s) the User code controls.

* with disarm privileges.

Partitioning (continued)

Area Bypass

This chart explains the procedure for Bypassing a faulted zone prior to arming a partition.

There may be occasions when it is desirable or necessary to temporarily bypass one or more zones prior to arming a partition. Bypass commands only work when the partition is disarmed. For instance, an open window may cause the 7140 display to read **NOT READY** followed by the faulted area number. If the area number is not showing after **NOT READY**,

press the [Command/#] key. The 7092 will light the faulted zone's LED.

Only one area may be bypassed each time the command is used. If more than one area requires bypassing, repeat the command for each area to be bypassed. A user can only bypass zones in the partition he has access to.

Note: See Force Arming for another method of area bypassing.

Bypass command	Enter User code followed by:	What will Happen DS7140 system	What will Happen DS7092 system	What to do
Bypass Faulted Zones	COMMAND BYPASS	"Area Bypass " will be displayed.	Bypassed zone LED will flash.	Arm partition(s), if desired, (entered zones bypassed).
Read Bypassed Zones	COMMAND BYPASS	"Area Bypass " will be displayed.		
Clear Individual Bypassed Zone(s)	COMMAND BYPASS	"Area Bypass" will be cleared.	LED for Bypassed zone will go back to steady on if the zone is still faulted.	
Clear All Bypassed Zones	COMMAND BYPASS RESET	All Bypasses will be cleared.	All Bypasses will be cleared.	

Arming and disarming partitions also clears bypassed zones, unless they are 24 hour zones.

Partitioning (continued)

About User codes

Partition Information

Note: See page 19 for complete information on User codes.

In order to perform any command functions while in Partition mode, User codes must be used. The User codes must correspond with the partition you wish work with. Some commands are partition dependent, that is, the command you choose (because of your User code) will only affect that partition your User code is assigned to.

- If you need access to partition 1 only, then your User code must begin with a 1.
- If you need access to partition 2 only, then your User code must begin with a 2.
- If you need access to both partitions simultaneously, then your User code must begin with a 0.

Master codes work the same way as User codes. Master codes beginning with a 1 are for use with partition 1 and can only change or create User codes that begin with a 1. Master codes beginning with 2 are for use with partition 2 and can only change or create User codes that begin with a 2. And Master codes that begin with a 0 are for use with both partitions and can change or create any User code.

Glossary

Access Control Code

A special code that activates electric door locks or other mechanisms.

Armed/Disarmed

When a burglar alarm system is activated, it is "armed." Turning the system off "disarms" it. Remember, fire protection (if installed) is always on.

Bypass

Deliberately excluding zones or areas of protection.

Central Station/Monitoring Service

A facility used to continuously monitor phone signals from your system. Trained personnel at the central station dispatch proper authorities as necessary.

Closing Report

A signal sent to a monitoring service to indicate the system has been armed. Some systems are programmed to send a "failure to close" signal if the system is not

armed by a designated time. Normally this feature is only used in commercial buildings.

Day Monitor Zones

These zones are used to supervise areas requiring 24 hour warning of entry. This feature is often used to monitor liquor or gun cabinets, or store rooms that require limited access. Violation of a day monitor zone during disarmed periods will result in activation of keypad sounders without sending any signals to the monitoring service. Violation during an armed period will cause a normal programmed alarm. The sounders may be silenced by any valid disarm User Code.

Dial Tone Test (Ring Back)

The control panel can be programmed to test for the presence of a phone line (dial tone) each time you arm the system. It can also perform a "ringback" test which gives a keypad beep or 1 second sounder signal after the control panel has

checked the phone line by calling the monitoring service. Exit delays will not start until the "ring back" sounder signal is heard or a communicator failure is detected (indicated by three beeps and a flashing Power LED). Local alarm sounders will operate even in the event of a communication or "ring back" failure.

Entry Delay

A predetermined amount of time that allows you to enter an armed building through designated entry doors. Normally a keypad pre-alert tone signals an entry delay in progress.

Exit Delay

A predetermined amount of time is given to leave after arming the system. You must exit the building through designated exit doors before the end of the exit delay.

Faulted Zone (Area)

If a zone is not ready to arm (e.g an open door or window), the zone is referred to as faulted or violated.

Force Arming

Arming the system by bypassing areas that are "Not Ready." Since this reduces the level of security, it should be avoided.

Interior Zone

Backup protection that warns of an intruder already inside your building. These devices may be bypassed when the system is armed in Perimeter Only modes.

Invisible Zone (24 hr.)

Twenty-four hour zones remain "active" even when the control panel is disarmed. These are normally used for items such as money clips, or silent hold-up buttons. When an alarm occurs in an invisible zone, the alarm will be sent to the monitoring service with absolutely no outward signs from keypad or sounders.

Local System

A system protected by a control panel **not** programmed to call a monitoring service. It sounds local bells or sirens when an intrusion or fire alarm is detected.

Monitored System

This system uses phone lines to notify a monitoring service of programmed abnormal events such as burglar or fire alarms.

Opening Report

A signal sent to a monitoring service indicating the system has been disarmed by entry of a user code. Some systems are programmed to send opening reports only if the opening is at an unscheduled time. Normally the feature is only used in commercial buildings.

Perimeter Zone

The first line of defense provided by switches or other detectors positioned to monitor exterior points of your building. These zones normally signal an instant alarm when they are violated, unless designated as Entry/Exit zones.

Residential/Commercial User Code Operation

A system programmed for simplified operation where user codes are only required to disarm the system is

sometimes referred to as a "residential" system. If the system is set up as a "commercial" system, user codes are required for all system commands.

Special Area Protection

A designated area, such as a drug storage area within a pharmacy, that can only be disarmed by certain user codes (11 -15).

When a special area user disarms the system with a code (11 - 15), the system will completely disarm. Users (1 - 10) can only disarm the part of the system that does not contain the special area. When they disarm the system, the yellow Alert LED will be left flashing to indicate special areas are still armed. Special areas can be armed using a custom arming sequence: [Command][4], [5] or [6].

User Code

A number entered by each user at the keypad to control the system. Each user has a User Code.

User Number

A number that represents a person who uses the system.

Index

- AC Power Failure**.....9, 21, 22
- Access Control**.....12, 36
- Access Control Code**.....12, 20, 36
- Alarm, Supplemental Keypad**.....15
- Alarm, Fire**.....13
- Alarm, Intrusion (Burglary)**.....13
- Alarm Sounds**.....13
- Alert Mode**.....11
- Alert Led**.....3, 4
- Area Bypass**.....10
- Area Test**.....23
- Armed/Disarmed**.....36
- Armed LED**.....3, 4
- Arming, Custom**.....8
- Arming**.....5, 6
- Arming, Forced**.....9
- Arming, Occupied with entry**.....5, 6
- Arming, Occupied no entry**.....5, 6
- Battery Power**.....21, 22
- Battery Test**.....24, 25
- Bypass**.....10, 36
- Central Station**.....36
- Closing Report**.....36
- Communicator Test**.....24, 25
- Communicator Failure**.....21, 22
- Control Panel**.....1
- Command Control Station**.....1
- Custom Arming**.....8
- Day Monitor Zones**.....36
- Dial Tone Test**.....36
- Disarming**.....7
- Display Information**.....3, 4
- Duress Code**.....14
- EEProm Error**.....21, 22
- Emergency Keypad Alarms**.....15
- Entry Delay**.....36
- Error Display**.....21, 22
- Exit Delay**.....36
- Faulted Zone**.....36
- Fire Alarms**.....13
- Fire LED**.....4
- Fire Reset**.....16
- Fire Trouble**.....16
- Force Arming**.....9, 37
- Function Code Digit**.....20
- Glass Break Sensors**.....1
- Indicator LED Test**.....24, 25
- Interior Motion Detectors**.....1
- Interior Zone**.....37
- Invisible Area**.....37
- Keypad Supplemental Alarm**.....15
- Light Test**.....24, 25
- Local System**.....37
- Low Battery**.....21, 22
- Magnetic Contacts**.....1
- Master Code**.....19, 20
- Monitored System**.....37
- Monitoring Service**.....36
- Opening Report**.....37
- Partial LED**.....3, 4
- Partitioning**.....27-35
- Perimeter**.....5, 37
- Power LED**.....3, 4
- Protected Zones**.....1
- Residential/Commercial**.....37
- Ring Back**.....26
- Silencing Alarms**.....7, 15
- Smoke Detectors**.....1
- Sounder Test**.....24, 25
- Status LED**.....3
- Temporary User Code**.....19, 20
- Twenty-four Hour Zone**.....37
- User Code**.....19, 20

Quick Reference Guide

System maintenance and service

Maintenance and Service

The system should be tested weekly to insure it is functioning properly. If problems are detected in testing or changes are noticed in normal operation, call your installing company for service. The manufacturer recommends replacing the system battery every 3 to 5 years.

Monitoring Service Phone No. _____

Monitoring Service System No. _____

Installing Company Phone No. _____

Area	Protected Area	Area	Partition
1	_____	1	_____
2	_____	2	_____
3	_____	3	_____
4	_____	4	_____
5	_____	5	_____
6	_____	6	_____
7	_____	7	_____
8	_____	8	_____

System Features Reference Guide

Audible Alarm Signalling Device Sounds

Intrusion () Pulse () Continuous
Fire () Pulse () Continuous

Keypad Supplemental Alarm [B] Key

() Continuous () Silent

- () This system has the Duress Alarm feature.
- () This system **does not have** the Duress Alarm feature.
- () This system has the communicator test feature.
- () This system does **not** have the communicator test.

Turning On (arming) Your System

Turn on all protection COMMAND 1
Occupied no entry allowed COMMAND 2
Occupied entry allowed COMMAND 3

Custom Arming

COMMAND 4 for _____
COMMAND 5 for _____
COMMAND 6 for _____

Force Arming

Enter arming command above followed by 9
Maximum number of zones that can be forced armed _____

Area Bypass

COMMAND 9 followed by the Area number

Turning Off (disarming) Your System

Enter your **User Code** followed by COMMAND

Partitioning

() Partitioning enabled
() Partitioning **not** enabled

Commands for Other System Features

Alert Mode	COMMAND 7
Area Test	COMMAND 8 1
Battery Test	COMMAND 8 0 or 8 5
Communicator Test	COMMAND 8 2
Error Display	COMMAND 8 7
Fire Reset	COMMAND 8 0
Alarm History Readback	COMMAND 8 9
Alarm History Reset	COMMAND 8 9 *
Indicator Light and Display Test	COMMAND 8 4
Sounder Test (alarm sounding devices) and Battery Test	COMMAND 8 5

Access Control

Enter your **Access Code** followed by COMMAND.

For **HELP**: Press and hold the RESET * key, then press the key for which help is desired (7140 only).

Detection Systems, Inc. 130 Perinton Parkway, Fairport, New York 14450
Technical Service (800) DSI-7454, Toll Free (800) 289-0096, Fax (716) 223-9180
374

P/N 26577B

Copyright © 1993 Detection Systems, Inc.

 Printed on recycled paper.

